

Article number: 021816011320

Description: Clamp with bracket and rubber  
SPGU 6011. 320/30 SK

## Measures

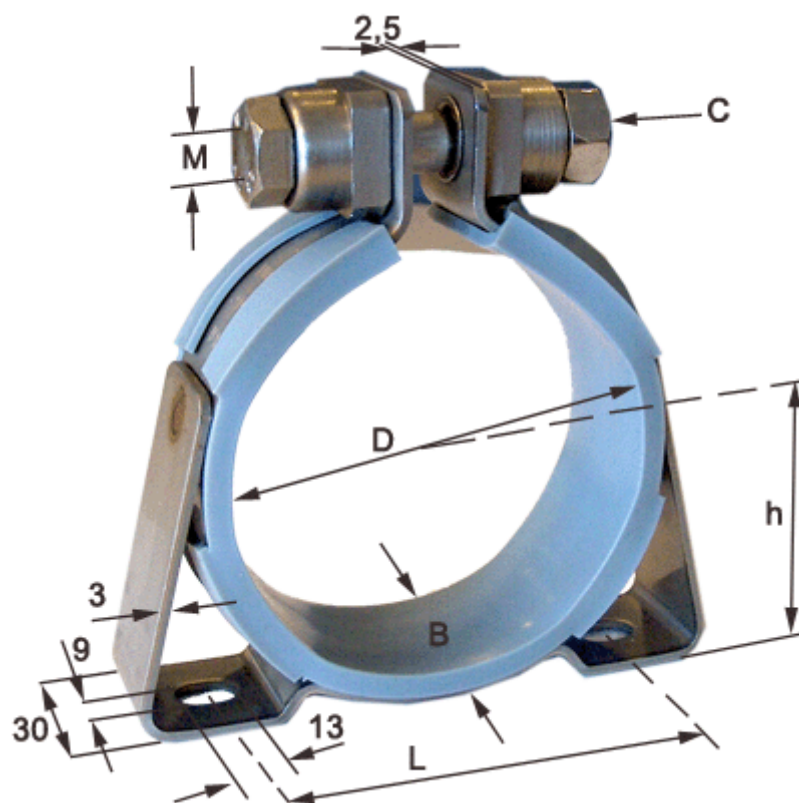

C (screw type) = SK hexagon screw

Diameter D = 320

h = 178

L = 280

Width B = 30